

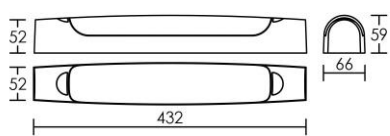













































	<b>MAUD SYM</b>			<b>Code / Réf</b>	
				53044	53045
				53046	53057
				53058	53059
				53062	53071
				53081	53082
				53083	53084
				53085	53086
53087	53088				

220-240V~ 50/60Hz	IK07	6,3 W	750°C							
----------------------	------	-------	-------	---	---	--	---	---	---	---

Code / Ref	CCT	Color / Couleur / Colore / Farbe	IP	IPXX	IP				Min Vol. (NFC15100)
									
53044 53062 53085 53087	2700 K			IP44					Vol. 2
53045 53081 53083				IP44					Vol. 2
53046				IP21					« Hors Volume »
53057 53071 53086 53088	4000 K			IP44					Vol. 2
53058 53082 53084				IP44					Vol. 2
53059				IP21					« Hors Volume »

FR	 Ne jetez pas vos déchets électriques avec les déchets ménagers. Confiez votre appareil à votre centre de recyclage pour son traitement approprié.	 Suivez la fiche d'instructions pour garantir un fonctionnement fiable et sécurisé. À conserver pour consultation ultérieure. Les produits doivent être installés par un électricien qualifié conformément aux normes internationales de câblage.
EN	Waste electrical products must not be disposed of with household waste. This tool should be taken to your recycling center for safe treatment.	Follow Instruction Sheet to ensure safe and reliable operation. Retain for future reference. Products should be installed by a qualified Electrician in accordance with International Wiring Regulations.
DE	Dieses Gerät darf nicht mit dem Hausmüll/Restmüll entsorgt werden. Das Altgerät nur in einer öffentlichen Sammelstelle abgeben.	Die Gebrauchsanweisung befolgen, damit der sichere und zuverlässige Betrieb gewährleistet ist. Zum späteren Nachschlagen aufheben. Die Produkte müssen von einem qualifizierten Elektriker in Übereinstimmung mit den relevanten Vorschriften installiert werden.
IT	I rifiuti elettrici non devono essere smaltiti con i rifiuti domestici. Questo strumento deve essere portato al centro di riciclaggio per un trattamento sicuro.	Seguire il foglio delle istruzioni per garantire il funzionamento sicuro e affidabile. Conservare per riferimento futuro. I prodotti devono essere installati da un elettricista qualificato conformemente alle normative internazionali sui cablaggi.
ES	Los productos eléctricos de desecho no deben ser eliminados con residuos domésticos. Esta herramienta debe ser llevada a su centro de reciclaje para un tratamiento seguro.	Siga la hoja de instrucciones para garantizar la seguridad y un funcionamiento fiable. Consérvela para utilizarla como material de referencia en el futuro. Los productos los debe instalar un técnico electricista cualificado en virtud de las normativas internacionales en materia de cableado.
FR	La source lumineuse (LED) contenue dans ce luminaire n'est pas remplaçable, lorsque la source lumineuse atteint sa fin de vie le luminaire entier doit être remplacé.	
EN	The light source (LED) contained in this luminaire is not replaceable, when the light source reaches its end of life the entire luminaire must be replaced.	
DE	Die in dieser Leuchte enthaltene Lichtquelle (LED) ist nicht auswechselbar, wenn die Lichtquelle ihre Lebensdauer erreicht, muss die gesamte Leuchte ersetzt werden.	
IT	La sorgente luminosa (LED) contenuta in questo apparecchio non è sostituibile, quando la sorgente luminosa raggiunge la fine della sua vita l'intero apparecchio deve essere sostituito.	
ES	La fuente luminosa (LED) contenida en esta luminaria no es sustituible, cuando la fuente luminosa llega a su fin de vida útil debe sustituirse toda la luminaria.	

	FR	Ce produit contient une source lumineuse de classe d'efficacité énergétique	 
	EN	This product contains a light source of energy efficiency class	
	DE	Dieses Produkt enthält eine Lichtquelle der Energieeffizienzklasse	
	IT	Questo prodotto contiene una sorgente luminosa di classe di efficienza energetica	
	ES	Este producto contiene una fuente luminosa de la clase de eficiencia energética	

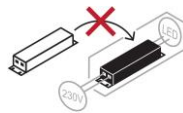