

Z.I des Ajeux - 72400 La Ferté-Bernard - France
Tél. : +33 (0)2 43 60 40 00 / Fax : +33 (0)2 43 60 40 09

 www.securlite.com

Produit, caractéristiques techniques et fonctionnalités

TITAN COMPACT Angle

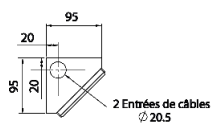

TITAN COMPACT Applique

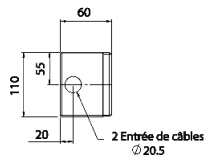

TITAN COMPACT E

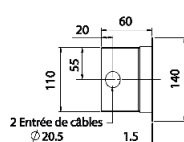

Entraxe (E) de fixation modèle applique et encastré :

250 mm (pour version 1 module LLC)
440 mm (pour version 2 modules LLC)
600 mm (pour version 3 modules LLC)
700 mm (pour version 4 modules LLC)

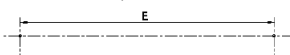

Entraxe (E) de fixation modèle angle :

120 mm (pour version 1 module LLC)
220 mm (pour version 2 modules LLC)
330 mm (pour version 3 modules LLC)
350 mm (pour version 4 modules LLC)

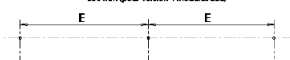

Dimensions encastrement (TITAN COMPACT E) :

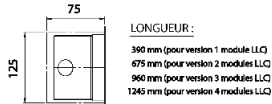

LONGUEUR :

350 mm (pour version 1 module LLC)
675 mm (pour version 2 modules LLC)
960 mm (pour version 3 modules LLC)
1245 mm (pour version 4 modules LLC)

Kit d'installation standard :

Rondelle Caoutchouc x2 (version Applique et Encastré) **ou** x3 (version Angle)
Rondelle Métallique x2 (version Applique et encastré) **ou** x3 (version Angle)
Presse étoupe laiton nickelé x1 (version Angle et Applique)
Bouchon anti-vandale x1 (version Angle et Applique)

Caractéristiques générales :

Tension nominale: 220 - 240V AC - 50 / 60 Hz
Plage de tension d'entrée: 198 - 264V AC
Classe de protection: I
Indice de protection: IP65
Indice de résistance aux chocs mécaniques: IK11+ / 80 j

Source lumineuse: LED - ce produit contient une source lumineuse de classe d'efficacité énergétique C.

Puissance(s): Se reporter à l'étiquette produit.

Référence(s): Se reporter à l'étiquette produit.

➤ Réf. générique: 64xxx00 sans détection (se reporter à cette notice).

Autre(s) référence(s) avec option(s):

➤ se reporter aux notices complémentaires.

Conditions d'utilisation

	TITAN COMPACT Applique	TITAN COMPACT Encastré	TITAN COMPACT A45
LED	OK	OK	OK

Montage / Installation



Attention, risque de chocs ESD sur les LEDs.



Le montage et l'installation doit être fait par un installateur professionnel en respectant les normes d'installation en vigueur.



Couper l'alimentation avant la pose et le branchement.

Ouverture du luminaire:

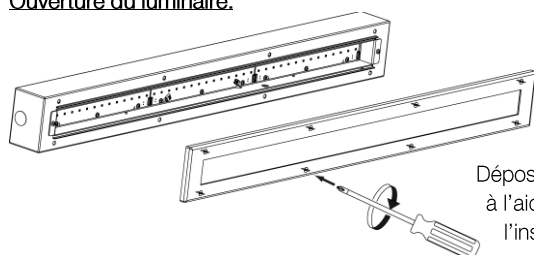

Déposer l'ensemble cadre + diffuseur à l'aide d'un tournevis adapté et de l'insert anti-vandale 98000003.

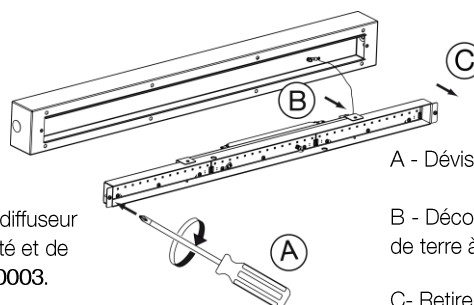

A - Dévisser la platine

B - Déconnecter la cosse de terre à la platine

C- Retirer la platine

Montage / Installation (suite)

Préparation passage et entrée de câble:

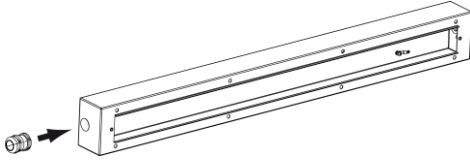

Fixation:

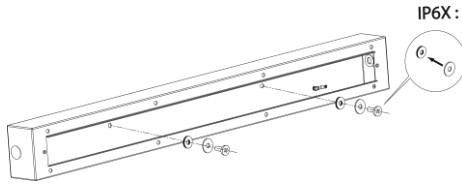

Afin de garantir l'étanchéité du luminaire l'utilisation d'un presse étoupe est impérative.

Utiliser un câble de type U1000R2V 1.5mm² (préconisé pour le respect de l'étanchéité).

Pour la fixation du luminaire, utiliser des vis de diamètre 5mm à tête plate et des chevilles adaptées au type de paroi pour avoir une résistance optimale à l'arrachement. Les vis et chevilles ne sont pas fournies avec le luminaire.

Utiliser les rondelles caoutchouc + rondelles métalliques afin de respecter l'étanchéité.

Raccordement électrique classe 1 (Réf. Générique 64xxx00):

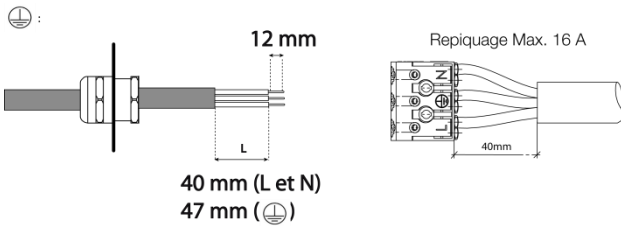

Le câble devra être dénudé selon schémas.

Respecter la polarité.

Mettre le cache supérieur du connecteur pour la classe II.

Raccordement électrique classe 2 (Réf. Générique 64xxx009502):

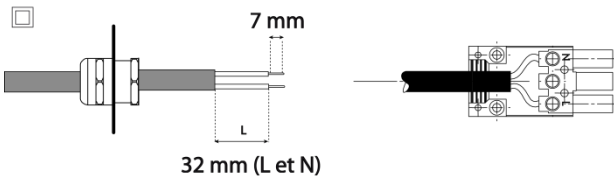

➤ Pour autres cas, se reporter aux notices particulières pour raccordement et repiquage.

Fermeture du luminaire:

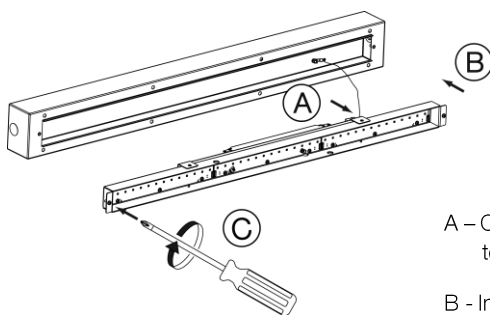

A – Connecter la cosse de terre à la platine

B - Insérer la platine

C – Visser la platine

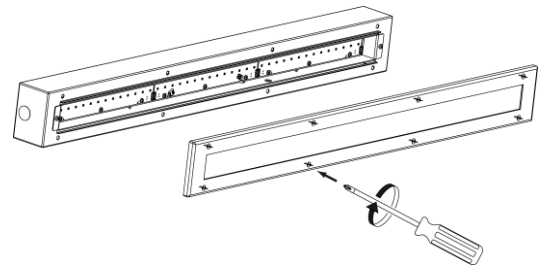

Refermer l'ensemble cadre + diffuseur à l'aide d'un tournevis adapté et de l'insert anti-vandale 98000003.

Entretien

L'entretien du luminaire se limite à un nettoyage du diffuseur pour une bonne luminosité, nettoyer le diffuseur (luminaire fermé) avec un chiffon humide ou à l'eau savonneuse.

 **NE PAS UTILISER DE DETERGENT**

Maintenance

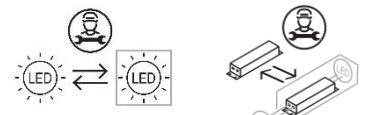

 La source lumineuse et l'appareillage contenus dans ce luminaire ne doivent être remplacés que par le fabricant, son agent de service ou une personne de qualification équivalente.

Recyclabilité



La gamme TITAN COMPACT est une gamme de luminaire éco-conçue:

- Toutes les pièces plastiques ou métalliques peuvent être démontées et recyclées dans une filière adaptée.
- Tous les composants électroniques tels que le circuit LED, l'alimentation, etc ... peuvent être démontés et recyclés dans une filière adaptée.

Z.I des Ajeux - 72400 La Ferté-Bernard - France
Tél. : +33 (0)2 43 60 40 00 / Fax : +33 (0)2 43 60 40 09

 www.securlite.com

Product technical characteristics and features

TITAN COMPACT Angle

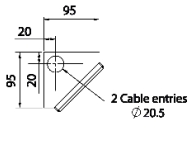

TITAN COMPACT Wall mounted

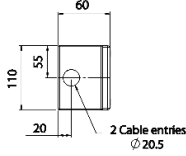

TITAN COMPACT E
(Recessed version)

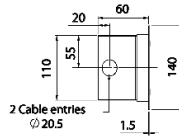

Standard installation kit:

Rubber washer **x2** (Wall mounted and Recessed version) **x3** (Angle version)
Metal washer **x2** (Wall mounted and Recessed version) **x3** (Angle version)
Nickel-plated cable gland **x1** (Angle and Wall mounted version)
Anti-vandal cup **x1** (Angle and Wall mounted version)

General characteristics:

Tension nominale: 220 - 240V AC – 50 / 60 Hz
Plage de tension d'entrée: 198 - 264V AC
Classe de protection: I
Indice de protection: IP65
Indice de résistance aux chocs mécaniques: IK11+ / 80 j

Light source: LED - this product contains a light source of energy efficiency class C.

Power(s): as per label product.

Reference(s): as per label product.

➤ Standard reference: 64xxxQ0 no detection (see this instruction).

Other reference(s) with option(s):

➤ See specific instructions.

Fitting (E) for wall mounting and recessed version :

266 mm (for version 1 module LLC)
440 mm (for version 2 modules LLC)
600 mm (for version 3 modules LLC)
790 mm (for version 4 modules LLC)

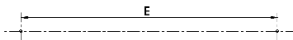

Fitting (E) for angle version :

120 mm (for version 1 module LLC)
220 mm (for version 2 modules LLC)
350 mm (for version 3 modules LLC)
350 mm (for version 4 modules LLC)



Recess dimensions (TITAN COMPACT E - Recessed version):

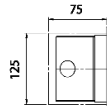

LENGTH:

390 mm (for version 1 module LLC)
675 mm (for version 2 modules LLC)
960 mm (for version 3 modules LLC)
1245 mm (for version 4 modules LLC)

Conditions of use

	TITAN COMPACT (Wall mounting version)	TITAN COMPACT (Recessed version)	TITAN COMPACT (Angle version)
LED	OK	OK	OK

Mounting / Installation



Warning! Versions using LEDs are susceptible to ESD (electrostatic discharge).



Fitting & installation must be carried out by a professional installer in accordance with current installation standards.



Isolate the power before fitting and connecting up.

Opening the luminaire:

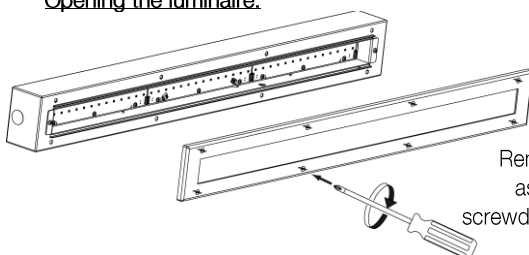

Remove the frame + diffuser assembly using a suitable screwdriver fitted with the 98000003 special bit.

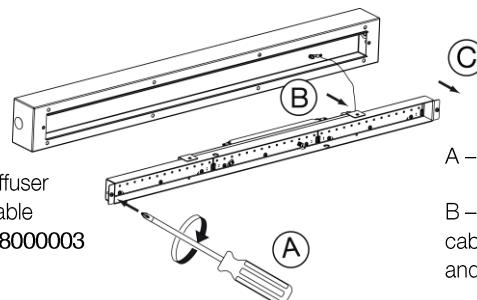

A – Unscrew the gear tray

B – Disconnect the earth cable between gear tray and body

Mounting / Installation

Preparing the cable entry grommet:

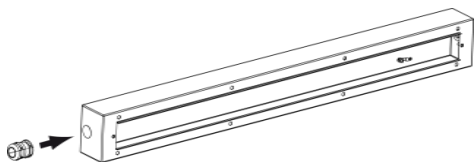

Fixing:

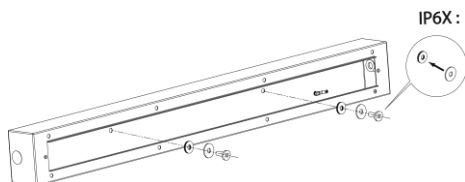

In order to ensure the luminaire is sealed, it is vital to use a cable gland suitable for an M20 hole. The unused cable entries must be blocked. Use 1.5 mm² U1000R2V type cable (recommended to maintain sealing).

For mounting the luminaire, use 5 mm diameter flat-headed screws with fixing plugs suitable for the type of wall, in order to achieve optimum rip-out resistance. The screws and plugs are not supplied with the luminaire. Use the rubber and metallic washer in order to maintain the sealing of the product.

Preparing the cable entry grommet class 1 (Standard reference 64xxxx00):

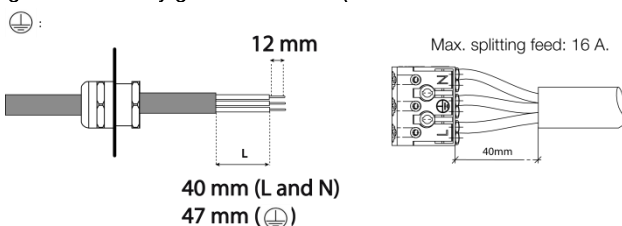

The cable must be prepared as per the diagrams. The conductors must be stripped for a length of 12 mm (Class I) or 7 mm (Class II). Respect the polarity. For Class II, fit the connector top cover.

➤ For other cases, refer to the specific instructions for connection and splitting off.

Preparing the cable entry grommet class 2 (Standard reference 64xxxx009502):

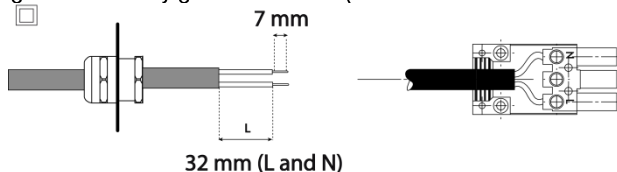

Closing the luminaire:

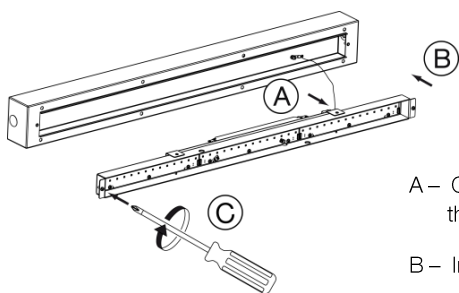

- A – Connect the earth cable between the body and the gear tray.
- B – Insert the gear tray.
- C – Screw up the gear tray

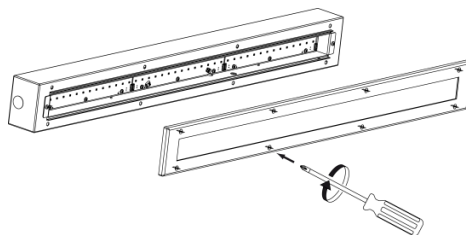

Refit the frame + diffuser assembly using a suitable screwdriver fitted with the **98000003** special bit.

Cleaning

Cleaning of the luminaire is limited to cleaning the diffuser for proper light output. Clean the diffuser (with the luminaire closed) using a damp cloth or with soapy water.

 **DO NOT USE DETERGENT**

Maintenance

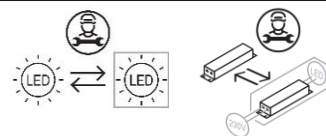

 The light source and the control gear contained in this luminaire must only be replaced by the manufacturer or his service agent or a similar qualified person.

Recyclability



The TITAN COMPACT is an eco-designed luminaire:

- All the plastic or metal components can be dismantled and recycled via appropriate facilities.
- All the electronic components such as the LED circuit, power supply, etc. can be dismantled and recycled via appropriate facilities.